

CATALOGO
CATALOGUE

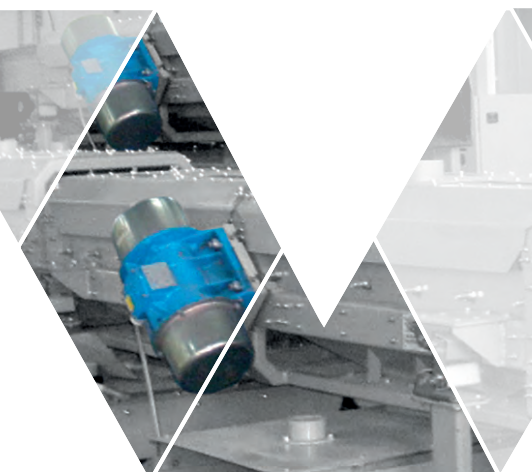

CAT. 22/06



VENANZETTI VIBRAZIONI MILANO
MOTOVIBRATORI - ELECTRIC VIBRATORS

QUALITÀ
QUALITY

EFFICIENZA
EFFICIENCY

AFFIDABILITÀ
RELIABILITY

Venanzetti Vibrazioni Milano rappresenta da oltre 70 anni un punto di riferimento nel campo della vibrazione industriale.

Passione qualità del prodotto e costante ricerca sono le caratteristiche che rendono il marchio Venanzetti un punto di riferimento globale in grado di offrire una vasta gamma di soluzioni.

Tutti i nostri prodotti sono interamente **costruiti in Italia**.



Venanzetti Vibrazioni Milano represent a point of reference in the field of industrial vibration for over 70 years.

Passion, quality and constant research are the characteristics that make Venanzetti a global reference offering a wide range of solutions.

All our products are totally **made in Italy**.

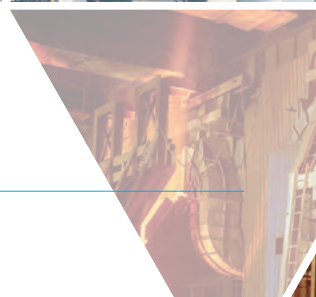

Motovibratori elettrici
Electric vibrators



VV

4

Motovibratori a sicurezza aumentata
Increase safety vibrators



VV E

14

VV C

16

Micro vibratori elettrici
Micro electric vibrators



VV MICRO

18

VV01N/2

20

Motovibratori in corrente continua
Direct current electric vibrators



VV CC

21

Oscillatori meccanici
Mechanical exciters



VMD

22



VV



VV
Compliance with applicable EU Directives.



VV
Ordinary locations
Class 4211 01 – Motors and generators
CAN/CSA C22.2 - No. 100-95
UL 1004-1
Certificate 1324136



VV
II2D (2014/34/UE)
Ex tb IIIC T...°C Db
EN 60079-0, EN 60079-31
Electric vibrators for dust explosive atmospheres
Cert. N. LCIE07ATEX6014X



VV
Ex tb IIIC T°...C Db
IEC 60079-0, IEC 60079-31
Electric vibrators for dust explosive atmospheres
Cert. IECEX LCIE 21.0020X



VV
Ex tb IIIC T°...C Db
EN IEC 60079-0, EN 60079-31
Electric vibrators for dust explosive atmospheres
Regulations 2016, UKSI 2016:1107 amended
by UKSI 2019 No.696



Product Quality Assurance Notification CESI
02 ATEX 112Q
Quality Assessment Report IT/CES/QAR20.0004

Motovibratori elettrici

Alimentazione

- Standard trifase 230/400V a 50Hz. A richiesta trifase da 24 a 690V a 50/60Hz. Fino alla grandezza EA a 2 e 4 poli anche in versione monofase 115V 50/60Hz e 230V 50/60Hz.
- Tropicalizzazione standard su tutta la gamma.
- Protezione dello statore con impregnazione sotto vuoto fino alla grandezza GA e goccia a goccia per le grandezze superiori.
- Classe di isolamento F (155°C) su richiesta classe H (180°C).
- Idonei al funzionamento con variatore di frequenza. Regolazione da 20Hz fino alla frequenza di targa a coppia costante.
- Termistor PTC 130°C a richiesta fino alla grandezza LA, di serie dalla grandezza MA. A richiesta scaldiglie anti condensa.

Funzionamento

- Temperatura di funzionamento da -20°C a + 40°C (su richiesta +55°C).
- Progettati per il funzionamento in continuo (S1) al 100% della forza centrifuga.
- Protezione meccanica IP 66.

Caratteristiche meccaniche

- Corpo motore in alluminio fino alla grandezza LA inclusa, in ghisa sferoidale per tutte le altre grandezze. Coperchi massa in acciaio inossidabile AISI 304.
- Cuscinetti in esecuzione speciale per servizio gravoso su macchine vibranti.
- Sistema a labirinto per la tenuta del grasso che assicura il mantenimento della corretta lubrificazione.
- Sistema di regolazione masse tramite indicatore graduato.

Trattamento superficiale

- Verniciatura standard (120 micron di spessore) con polveri epossidiche polimerizzate a 200°C testata in nebbia salina per 500 ore.
- Su richiesta rivestimento in resina poliuretana STEEL IT (approvazione USDA) per utilizzo nel settore alimentare.

Electric vibrators

Power Supply

- *Standard three-phase 230/400V 50Hz. On request three-phase from 24 to 690V 50/60Hz. Up to size EA at 2 and 4 poles available single phase 115V 50/60Hz and 230V 50/60Hz.*
- *Tropicalization standard on all vibrators.*
- *Winding insulation with vacuum incapsulating up to GA size included, drop by drop system from HA size.*
- *Insulation class F (155°C) on request class H (180°C).*
- *Suitable for operation with inverter (VFD) from 20Hz up to the rated frequency with constant torque load.*
- *Thermistor PTC 130°C at request up to size LA, standard from size MA. On request anti condensation heaters.*

Functioning

- *Working temperature from -20°C a + 40°C (on request +55°C).*
- *Designed for continuous duty (S1) with 100% centrifugal force CF.*
- *Standard mechanical protection IP 66.*

Mechanical features

- *Motor casing in aluminium up to size LA included, spheroidal cast iron from all other sizes. Weight covers in stainless steel AISI 304 for all the range.*
- *Special execution bearings for continuous operation at 100%.*
- *Labyrinth system for grease sealing to ensure the correct lubrication.*
- *Eccentric weights regulation system with graduated scale.*

Surface coating

- *Standard coating (120 micron thickness) with epoxy powder polymerized at 200°C. Surface treatment tested in salt spray for 500 hours.*
- *On request polyurethane resin coating STEEL IT (USDA approved) suitable for food industry.*

2 poli trifase 3000/3600 giri – 2 poles three-phase 3000/3600 rpm

Descrizione Description					Caratteristiche Meccaniche Mechanical Specifications						Caratteristiche Elettriche Electrical Specifications			
Codice Code	Tipo Type	Grandezza Size	II 2 D Temp. Class		Momento Statico Static Moment		Forza Centrifuga Centrifugal Force				Potenza assorbita Max Max. Input Power		Corrente Max (A) Max. Input Current (A)	
					kgmm		kg		kN		(W)		400V 50Hz	460V 60Hz
					50Hz	60Hz	50Hz	60Hz	50Hz	60Hz	50Hz	60Hz	50Hz	60Hz
V2021	VV03N/2	BA	120°C	•	12	12	120	175	1,18	1,72	170	170	0,33	0,29
V2022	VV05N/2	BA	120°C	•	20	15	205	214	2,01	2,10	170	170	0,33	0,29
V2023	VV10N/2	CA	120°C	•	32	21	320	310	3,14	3,04	250	260	0,57	0,48
V2017	VV15N/2	DA	120°C	•	52	34	520	490	5,10	4,81	430	470	0,76	0,71
V2026	VV22N/2	DA	120°C	•	72	52	730	749	7,16	7,35	430	470	0,76	0,71
V2020	VV25N/2	EA	120°C	•	80	53	800	770	7,85	7,55	610	650	1,0	0,95
V2024	VV35N/2	GA	120°C	•	114	76	1150	1100	11,3	10,8	950	1100	1,6	1,6
V2025	VV38N/2	HA	-	•	159	104	1600	1500	15,7	14,7	1900	1900	3,20	2,80
V2027	VV39N/2	HA	-	•	180	130	1810	1880	17,8	18,4	1900	1900	3,20	2,80
V2028	VV39.5N/2**	IB	135°C*	•	207	130	2080	1880	22,3	18,4	2100	2100	3,40	2,90
V2007	VV40N/2**	IB	135°C*	•	234	155	2350	2250	23,1	22,1	2100	2100	3,4	2,9
V2008	VV45N/2	MB	-	•	324	220	3250	3200	31,9	31,4	3800	3800	6,2	5,4
V2009	VV55N/2	MB	-	•	399	261	4000	3800	39,2	37,3	3800	3800	6,2	5,4
V2013	VV67N/2	OA	135°C	•	636	445	6400	6450	62,8	63,3	5300	5300	8,8	7,7
V2011	VV71N/2	PA	-	-	895	621	9000	9000	88,3	88,3	9400	8800	17,0	12,3

* Certificazione disponibile solo per vibratore con termistore / Certification available only for vibrator fitted with termistor

** Coperchi masse in alluminio / Aluminum weight covers

Monofase – Single-phase

Descrizione Description					Caratteristiche Meccaniche Mechanical Specifications						Caratteristiche Elettriche Electrical Specifications			
Cod. Code	Tipo Type	Grandezza Size	II 2 D Temp. Class		Momento Statico Static Moment		Forza Centrifuga Centrifugal Force				Potenza assorbita Max Max. Input Power		Corrente Max (A) Max. Input Current (A)	
					kgmm		kg		kN		(W)		230V 50Hz	115V 60Hz
					50Hz	60Hz	50Hz	60Hz	50Hz	60Hz	50Hz	60Hz	50Hz	60Hz
V2021	VV03N/2	BA	120°C	•	12	12	120	175	1,18	1,72	155	155	0,70	1,50
V2022	VV05N/2	BA	120°C	•	20	15	205	214	2,01	2,10	155	155	0,70	1,50
V2023	VV10N/2	CA	120°C	•	32	21	320	310	3,14	3,04	270	270	1,20	2,30
V2017	VV15N/2	DA	120°C	•	52	34	520	490	5,10	4,81	480	480	2,20	4,20
V2026	VV22N/2	DA	120°C	•	72	52	730	749	7,16	7,35	480	480	2,20	4,40
V2005	VV25N/2	EA	120°C	•	80	53	800	770	7,85	7,55	650	700	3,10	6,50

Ref.1

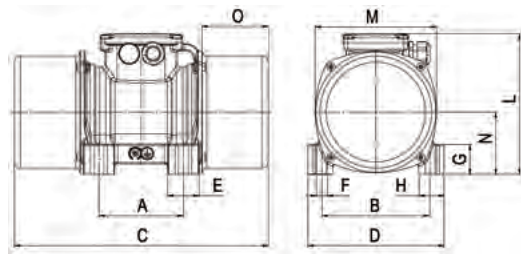

Ref.2

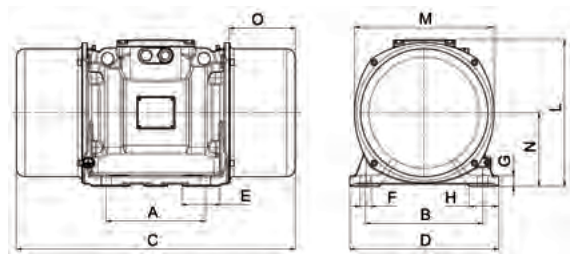

Dimensioni (mm)
Dimensional Specifications (mm)

Peso Weight (kg.)	Ref.	Distanze di Fissaggio Fixing distances		C	D	E	Fori Fissaggio Fixing holes		G	H	L	M	N	O	Pressacavo Cable gland
		A	B				ØF	N°							
50Hz 60Hz															
5,6	1	62-74	106	209	125	30	9	4	22	22,5	150	117	61	45	M20x1,5
6,2	1	62-74	106	225	125	30	9	4	22	22,5	150	117	61	53	M20x1,5
9,5	1	90	125	255	152	34	13	4	28	30	171	141	73	54	M20x1,5
14,8	1	105	140	284	167	38	13	4	30	31	203	160	82,5	63	M25x1,5
15,1	1	105	140	284	167	38	13	4	30	31	203	160	82,5	63	M25x1,5
19,6	1	120	170	308	205	47	17	4	45	37,5	211	182	93,5	63	M25x1,5
25	1	120	170	354	205	42	17	4	42	40	224	203	104,5	77	M25x1,5
36	1	140	190	438	230	50	17	4	45	45	244	225	116	103	M25x1,5
37	1	140	190	438	230	50	17	4	45	45	244	225	116	103	M25x1,5
53	1	140	190	465	230	40	17	4	49	45	232	200	104	105	M25x1,5
53	1	140	190	465	230	40	17	4	49	45	232	200	104	105	M25x1,5
105	1	155	255	546	310	55	25	4	91	63	289	253	130	130	M25x1,5
110	1	155	255	546	310	55	25	4	91	63	289	253	130	130	M25x1,5
188	2	200	320	662	380	106	28	4	28	80	364	356	183	151	M32x1,5
217	2	200	320	624	390	106	28	4	30	95	392	378	192	132	M32x1,5

Dimensioni (mm)
Dimensional Specifications (mm)

Peso Weight (kg.)	Ref.	Distanze di Fissaggio Fixing distances		C	D	E	Fori Fissaggio Fixing holes		G	H	L	M	N	O	Condensatore (µF) Capacitor (µF)		Pressacavo Cable gland
		A	B				ØF	N°							230V 50Hz	115V 60Hz	
50Hz 60Hz																	
5,6	1	62-74	106	209	125	30	9	4	22	22,5	150	117	61	45	10	28	M20x1,5
6,2	1	62-74	106	225	125	30	9	4	22	22,5	150	117	61	53	10	28	M20x1,5
9,5	1	90	125	255	152	34	13	4	28	30	171	141	73	54	16	25	M20x1,5
14,8	1	105	140	284	167	38	13	4	30	31	203	160	82,5	63	12,5	50	M25x1,5
15,1	1	105	140	284	167	38	13	4	30	31	203	160	82,5	63	12,5	50	M25x1,5
20,5	1	120	170	308	205	47	17	4	45	37,5	211	182	93,5	63	25	90	M25x1,5



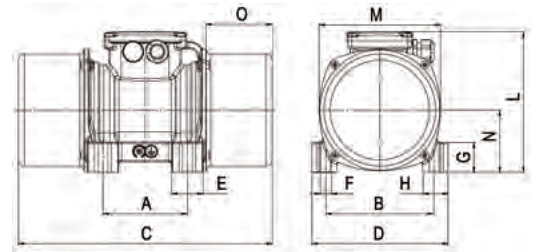

4 poli trifase 1500/1800 giri – 4 poles three-phase 1500/1800 rpm

Descrizione – Description					Caratteristiche Meccaniche – Mechanical Specifications						Caratteristiche Elettriche – Electrical Specifications			
Codice Code	Tipo Type	Grandezza Size	II 2 D Temp. Class		Momento Statico Static Moment		Forza Centrifuga Centrifugal Force				Potenza assorbita Max Max. Input Power		Corrente Max (A) Max. Input Current (A)	
					kgmm		kg		kN		(W)		400V 50Hz	460V 60Hz
					50Hz	60Hz	50Hz	60Hz	50Hz	60Hz	50Hz	60Hz		
V4021	VV03B/4	BA	120°C	•	12,6	12,6	31,7	45,7	0,311	0,448	80	90	0,20	0,19
V4022	VV05B/4	BA	120°C	•	32,0	22,1	80,4	79,4	0,789	0,779	80	90	0,20	0,19
V4023	VV06B/4	BA	120°C	•	39,8	32,0	100	115	0,981	1,13	80	90	0,20	0,19
V4024	VV10B/4	CA	120°C	•	87,0	60,8	220	220	2,16	2,16	160	160	0,38	0,38
V4025	VV20B/4	DA	120°C	•	167	116	420	420	4,12	4,12	280	330	0,57	0,57
V4015	VV21B/4	DA	120°C	•	222	167	550	600	5,40	5,89	280	330	0,56	0,56
V4030	VV30B/4	EA	120°C	•	298	215	750	780	7,36	7,65	500	620	0,88	0,93
V4032	VV32B/4	EA	120°C	•	362	289	910	1050	8,93	10,3	500	620	0,88	0,93
V4031	VV35B/4	GA	120°C	•	437	276	1100	1000	10,8	9,81	520	640	0,9	0,9
V4006	VV38B/4	HA	120°C	•	556	387	1400	1400	13,7	13,7	850	1000	1,37	1,43
V4007	VV40B/4	IA	135°C	•	714	483	1800	1750	17,7	17,2	1100	1200	1,91	1,83
V4016	VV41B/4	IA	135°C	•	833	556	2100	2050	20,6	20,1	1300	1400	2,40	2,20
V4008	VV50B/4	LA	150°C	•	992	691	2500	2500	24,5	24,5	1500	1600	3,00	2,90
V4017	VV53B/4	LA	135°C	•	1250	870	3150	3150	30,9	30,9	1800	1900	3,60	3,30
V4009	VV55B/4	MA	135°C	•	1508	1050	3800	3800	37,3	37,3	2100	2400	3,8	3,7
V4018	VV57B/4	MA	135°C	•	1746	1188	4400	4300	43,2	42,2	2400	2700	4,6	4,4
V4010	VV60B/4	NA	135°C	•	1984	1367	5000	4950	49,1	48,6	3400	3200	5,70	4,80
V4033	VV62B/4	NA	135°C	•	2262	1479	5700	6100	55,9	59,8	3400	3200	5,70	4,80
V4011	VV67B/4	OA	135°C	•	2619	1823	6600	6600	64,7	64,7	5700	5700	10,0	8,60
V4012	VV71B/4	PA	135°C	▲	3175	2210	8200	8200	80,4	80,4	6600	7600	11,0	10,9
V4013	VV81B/4	QA	135°C	▲	3373	2486	8500	9000	83,4	88,3	7100	8000	11,5	11,3

▲ Certificazione CSA disponibile su richiesta, con cavo di alimentazione incluso / CSA certification on request, power supply cable included

Monofase – Single-phase

Descrizione – Description					Caratteristiche Meccaniche – Mechanical Specifications						Caratteristiche Elettriche – Electrical Specifications			
Cod. Code	Tipo Type	Grandezza Size	II 2 D Temp. Class		Momento Statico Static Moment		Forza Centrifuga Centrifugal Force				Potenza assorbita Max Max. Input Power		Corrente Max (A) Max. Input Current (A)	
					kgmm		kg		kN		(W)		230V 50Hz	115V 60Hz
					50Hz	60Hz	50Hz	60Hz	50Hz	60Hz	50Hz	60Hz		
V4021	VV03B/4	BA	120°C	•	12,6	12,6	31,7	45,7	0,311	0,448	90	90	0,43	0,90
V4022	VV05B/4	BA	120°C	•	32,0	22,1	80	80	0,785	0,785	90	90	0,43	0,90
V4023	VV06B/4	BA	120°C	•	39,8	32,0	100	115	0,981	1,113	90	90	0,43	0,90
V4024	VV10B/4	CA	120°C	•	87,0	60,8	220	220	2,16	2,16	200	220	0,95	1,91
V4025	VV20B/4	DA	120°C	•	167	116	420	420	4,12	4,12	230	300	1,15	2,60
V4015	VV21B/4	DA	120°C	•	222	166	550	600	5,40	5,89	230	300	1,15	2,60
V4030	VV30B/4	EA	120°C	•	298	215	750	780	7,36	7,65	400	500	2,00	4,90

* Condensatore di marcia/Condensatore di avviamento - Running capacitor/Starting capacitor

Ref.2

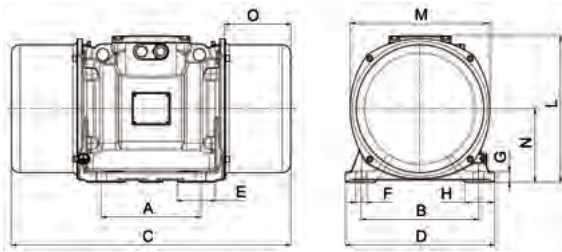

Ref.3

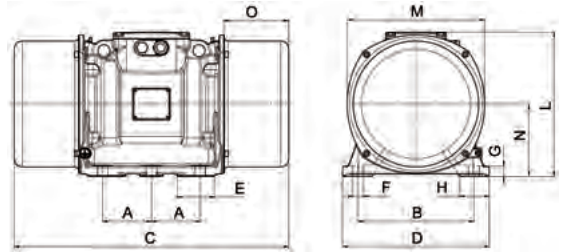

Dimensioni (mm) – Dimensional Specifications (mm)

Peso Weight (kg.)		Ref.	Distanze di Fissaggio Fixing distances			Fori Fissaggio Fixing holes				G	H	L	M	N	O	Pressacavo Cable gland
50Hz	60Hz		A	B	C	D	E	ØF	N°							
5,6	5,6	1	62-74	106	209	125	30	9	4	22	22,5	150	117	61	45	M20x1,5
6,6	6,3	1	62-74	106	241	125	30	9	4	22	22,5	150	117	61	61	M20x1,5
6,9	6,6	1	62-74	106	241	125	30	9	4	22	22,5	150	117	61	61	M20x1,5
12,5	11,5	1	90	125	295	152	34	13	4	28	30	171	141	73	74	M20x1,5
19	18	1	105	140	340	167	38	13	4	30	31	203	160	82,5	91	M25x1,5
20,5	19	1	105	140	380	167	38	13	4	30	31	203	160	82,5	111	M25x1,5
27	25,7	1	120	170	382	205	47	17	4	45	37,5	211	182	93,5	100	M25x1,5
29	27	1	120	170	442	205	47	17	4	45	37,5	211	182	93,5	130	M25x1,5
35	30	1	120	170	436	205	42	17	4	42	40	224	203	104,5	118	M25x1,5
42	39	1	140	190	438	230	50	17	4	45	45	244	225	116	103	M25x1,5
50	48	1	140	190	490	230	50	17	4	45	45	244	225	116	129	M25x1,5
51	49	1	140	190	560-50 490-60	230	50	17	4	45	45	244	225	116	164 (50Hz) 129 (60Hz)	M25x1,5
72	67	1	155	225	523	275	55	22	4	70	55	272	253	130	130	M25x1,5
81	75	1	155	225	601	275	55	22	4	70	55	272	253	130	169	M25x1,5
118	113	2	155	255	589	315	81	23,5	4	22	63	309	295	155	139,5	M25x1,5
125	120	2	155	255	589	315	81	23,5	4	22	63	309	295	155	139,5	M25x1,5
174	166	2	180	280	638	345	99	26	4	28	77,5	346	320	165	154	M32x1,5
177	168	2	180	280	638	345	99	26	4	28	77,5	346	320	165	154	M32x1,5
212	200	2	200	320	662	380	106	28	4	28	80	364	356	183	151	M32x1,5
228	213	2	200	320	624	390	106	28	4	30	95	392	378	192	132	M32x1,5
319	305	3	125	380	862	460	76	39	6	35	107,5	431	414	215	230	M32x1,5

Dimensioni (mm) – Dimensional Specifications (mm)

Peso Weight (kg.)		Ref.	Distanze di Fissaggio Fixing distances			Fori Fissaggio Fixing holes				G	H	L	M	N	O	Condensatore (µF) Capacitor (µF)		Pressacavo Cable gland
50Hz	60Hz		A	B	C	D	E	ØF	N°							230V 50Hz	115V 60Hz	
5,6	5,6	1	62-74	106	209	125	30	9	4	22	22,5	150	117	61	45	3,15	25	M20x1,5
6,6	6,3	1	62-74	106	241	125	30	9	4	22	22,5	150	117	61	61	3,15	25	M20x1,5
6,9	6,6	1	62-74	106	241	125	30	9	4	22	22,5	150	117	61	61	3,15	25	M20x1,5
12,3	11,5	1	90	125	295	152	34	13	4	28	30	171	141	73	74	5	25	M20x1,5
19	18	1	105	140	340	167	38	13	4	30	31	203	160	82,5	91	12/20*	35	M25x1,5
21	20	1	105	140	380	167	38	13	4	30	31	203	160	82,5	111	12/20*	35/5*	M25x1,5
28	26	1	120	170	382	205	47	17	4	45	37,5	211	182	93,5	100	16/80*	40/120*	M25x1,5



Ref.1

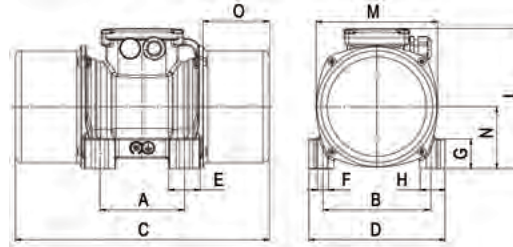

Ref.2

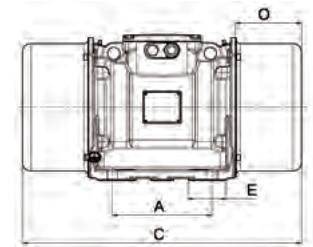

6 poli trifase 1000/1200 giri – 6 poles three-phase 1000/1200 rpm

Descrizione – Description					Caratteristiche Meccaniche – Mechanical Specifications						Caratteristiche Elettriche – Electrical Specifications			
Codice Code	Tipo Type	Grandezza Size	 II 2 D Temp. Class		Momento Statico Static Moment		Forza Centrifuga Centrifugal Force				Potenza assorbita Max Max. Input Power		Corrente Max (A) Max. Input Current (A)	
					kgmm	kg	kN		(W)		400V 50Hz	460V 60Hz		
					50Hz	60Hz	50Hz	60Hz	50Hz	60Hz	50Hz	60Hz	50Hz	60Hz
V6027	VV10B/6	CA	120°C	•	35,8	31,1	40	50	0,39	0,49	115	130	0,29	0,29
V6028	VV11B/6	CA	120°C	•	89,3	87	100	140	0,98	1,37	115	130	0,29	0,29
V6029	VV20B/6	DA	120°C	•	167	167	188	270	1,84	2,65	180	200	0,48	0,48
V6035	VV30B/6	EA	120°C	•	298	215	335	348	3,29	3,41	330	360	0,68	0,65
V6036	VV35B/6	GA	120°C	•	446	446	500	718	4,91	7,04	330	360	0,71	0,65
V6037	VV38B/6	HA	135°C	•	714	555	800	900	7,85	8,83	640	720	1,30	1,30
V6038	VV40B/6	IA	135°C	•	982	710	1100	1150	10,8	11,3	710	710	1,60	1,30
V6039	VV41B/6	IA	135°C*	•	1339	937	1500	1500	14,7	14,7	900	950	2,00	1,90
V6040	VV50B/6	LA	135°C	•	1518	992	1700	1597	16,7	15,7	1000	1300	2,10	2,10
V6041	VV53B/6	LA	135°C	•	1964	1375	2200	2200	21,6	21,6	1400	1600	2,80	2,70
V6006	VV55B/6	MA	135°C	•	2321	1615	2600	2600	25,5	25,5	1800	2000	2,9	3,6
V6020	VV57B/6	MA	135°C	•	2767	2000	3100	3200	30,4	31,4	2100	2300	4,3	4,1
V6007	VV60B/6	NA	135°C	•	3482	2422	3900	3900	38,3	38,3	2400	2800	4,8	4,7
V6021	VV62B/6	NA	135°C	•	4285	2937	4800	4700	47,1	46,1	3100	3500	6,30	5,80
V6008	VV65B/6	OA	135°C	•	4732	3292	5300	5300	52,0	52,0	3600	3800	6,7	6,2
V6042	VV66B/6	OA	135°C	•	5089	3509	5700	5650	55,9	55,4	3600	3800	6,7	6,2
V6009	VV67B/6	OA	135°C	•	5835	4050	6525	6520	64,0	64,0	4100	4700	7,7	7,6
V6043	VV69B/6	OA	135°C	•	6294	4379	7050	7050	69,2	69,2	4100	4700	7,7	7,6
V6010	VV71B/6	PA	135°C	▲	7232	5031	8100	8100	79,5	79,5	6600	7100	11,9	10,7
V6011	VV75B/6	PA	135°C	▲	7768	5404	8700	8700	85,3	85,3	7100	7700	13,2	12,1
V6012	VV81B/6	QA	135°C	▲	8750	6087	9800	9800	96,1	96,1	7200	7500	12,8	11,6
V6024	VV110B/6	QA	135°C	▲	10000	6964	11300	11000	111	108	7500	7900	13,0	12,0
V6025	VV130B/6	QA	135°C	▲	11607	8200	13000	13200	128	129	9200	9600	16,3	15,4
V6014	VV141B/6	SA	-	▲	12679	8758	14200	14100	139	138	10200	11000	18,3	17,6
V6015	VV171B/6	SA	-	▲	15625	10560	17500	17000	172	167	12500	13000	23,6	21,9
V6044	VV191B/6	SA	-	▲	17946	11492	20100	18500	197	181	12500	13000	23,6	21,9
V6016	VV221B/6	TA	-	▲	20090	12670	22500	20400	221	200	18300	18300	31,8	24,6
V6026	VV250B/6	TA	-	▲	22322	-	25000	-	245	-	18300	-	31,8	-

* Certificazione disponibile solo per vibratore con termistore / Certification available only for vibrator fitted with termistor

▲ Certificazione CSA disponibile su richiesta, con cavo di alimentazione incluso / CSA certification on request, power supply cable included

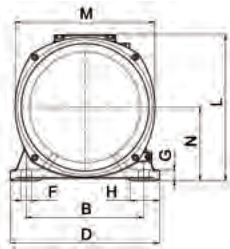

Ref.3

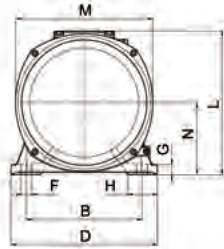
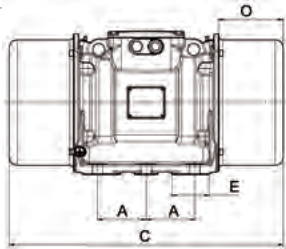

Ref.4

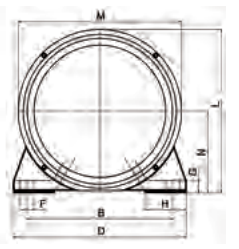
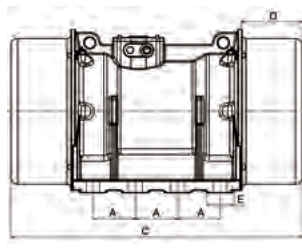

Dimensioni (mm) – Dimensional Specifications (mm)

Peso Weight (kg.)		Ref.	Distanze di Fissaggio Fixing distances			Fori Fissaggio Fixing holes				G	H	L	M	N	O	Pressacavo Cable gland
50Hz	60Hz		A	B	C	D	E	ØF	N°							
9,6	9,6	1	90	125	255	152	34	13	4	28	30	171	141	73	54	M20x1,5
12,3	12,3	1	90	125	295	152	34	13	4	28	30	171	141	73	74	M20x1,5
19	19	1	105	140	340	167	38	13	4	30	31	203	160	82,5	91	M25x1,5
27	25,7	1	120	170	382	205	47	17	4	45	37,5	211	182	93,5	100	M25x1,5
36	36	1	120	170	436	205	42	17	4	42	40	224	203	104,5	118	M25x1,5
46	41	1	140	190	490-50 438-60	230	50	17	4	45	45	244	225	116	129-50 103-60	M25x1,5
57	48	1	140	190	560	230	50	17	4	45	45	244	225	116	164	M25x1,5
68	61	1	140	190	560	230	50	17	4	45	45	244	225	116	187	M25x1,5
82	72	1	155	225	600-50 523-60	275	55	22	4	70	55	272	253	130	169-50 130-60	M25x1,5
95	83	1	155	225	655-50 600-60	275	55	22	4	70	55	272	253	130	196-50 169-60	M25x1,5
133	120	2	155	255	657-50 589-60	315	81	23,5	4	22	63	309	295	155	173,5-50 139,5-60	M25x1,5
148	133	2	155	255	706	315	81	23,5	4	22	63	309	295	155	198	M25x1,5
201	183	2	180	280	730	345	99	26	4	28	77,5	346	320	165	200	M32x1,5
217	196	2	180	280	790-50 730-60	345	99	26	4	28	77,5	346	320	165	230-50 200-60	M32x1,5
242	220	2	200	320	735	380	106	28	4	28	80	364	356	183	187,5	M32x1,5
244	225	2	200	320	826	380	106	28	4	28	80	364	356	183	233	M32x1,5
267	257	2	200	320	826	380	106	28	4	28	80	364	356	183	233	M32x1,5
274	262	2	200	320	826	380	106	28	4	28	80	364	356	183	233	M32x1,5
320	285	2	200	320	854	390	106	28	4	30	95	392	378	192	247	M32x1,5
330	292	2	200	320	854	390	106	28	4	30	95	392	378	192	247	M32x1,5
383	343	3	125	380	862	460	76	39	6	35	107,5	431	414	215	230	M32x1,5
402	363	3	125	380	1002	460	76	39	6	35	107,5	431	414	215	300	M32x1,5
440	385	3	125	380	1002	460	76	39	6	35	107,5	431	414	215	300	M32x1,5
638	600	4	140	480	960	570	90	45	8	41	135	537	538	268	200	M32x1,5
705	651	4	140	480	1040	570	90	45	8	41	135	537	538	268	240	M32x1,5
711	656	4	140	480	1120	570	90	45	8	41	135	537	538	268	280	M32x1,5
920	890	4	140	520	1150	610	90	45	8	38	145	612	594	297	298	M32x1,5
950	-	4	140	520	1150	610	90	45	8	38	145	612	594	297	298	M32x1,5

Ref.1

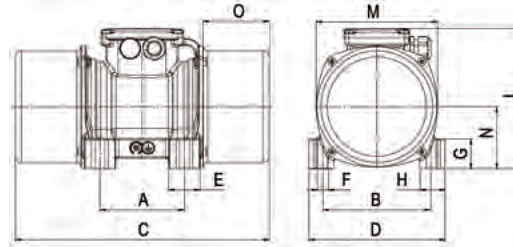

Ref.2

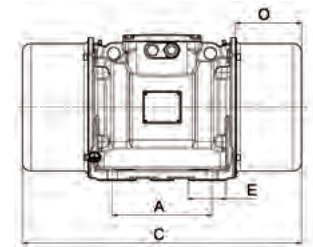

8 poli trifase 750/900 giri – 8 poles three-phase 750/900 rpm

Descrizione – Description					Caratteristiche Meccaniche – Mechanical Specifications						Caratteristiche Elettriche – Electrical Specifications			
Codice Code	Tipo Type	Grandezza Size	II 2 D Temp. Class		Momento Statico Static Moment		Forza Centrifuga Centrifugal Force				Potenza assorbita Max Max. Input Power		Corrente Max (A) Max. Input Current (A)	
					kgmm		kg		kN		(W)		400V 50Hz	460V 60Hz
					50Hz	60Hz	50Hz	60Hz	50Hz	60Hz	50Hz	60Hz		
V8019	VV20B/8	DA	130°C	•	167	167	113	163	1,11	1,60	210	230	0,80	0,71
V8023	VV30B/8	EA	130°C	•	298	298	189	271	1,85	2,66	330	360	1,00	1,00
V8024	VV35B/8	GA	120°C	•	446	446	281	490	2,76	4,81	260	280	0,57	0,55
V8025	VV38B/8	HA	120°C	•	714	714	450	650	4,41	6,38	370	420	1,10	1,10
V8026	VV40B/8	IA	120°C	•	982	982	619	894	6,07	8,77	370	470	1,30	1,20
V8027	VV50B/8	LA	150°C	•	1518	1518	956	1381	9,38	13,5	900	1000	2,10	2,10
V8028	VV53B/8	LA	135°C	•	1937	1937	1220	1762	12,0	17,3	1050	1250	2,50	2,50
V8006	VV55B/8	MA	135°C	•	2321	2321	1462	2112	14,3	20,7	1400	1700	3,60	3,70
V8007	VV60B/8	NA	135°C	•	3482	3482	2194	3167	21,5	31,1	1900	2200	5,10	5,00
V8016	VV62B/8	NA	135°C	•	4285	4285	2700	3900	26,5	38,3	2400	2800	5,80	5,80
V8008	VV65B/8	OA	135°C	•	4732	4732	2981	4306	29,2	42,2	2700	3200	6,20	6,20
V8009	VV67B/8	OA	135°C	•	5714	5714	3600	5200	35,3	51,0	3800	4100	7,70	7,40
V8010	VV71B/8	PA	135°C	▲	7232	7232	4556	6581	44,7	64,6	4700	5500	9,40	9,00
V8029	VV74B/8	QA	135°C	▲	7381	7381	4650	6720	45,6	65,9	5500	5900	10,3	9,80
V8011	VV81B/8	QA	135°C	▲	12700	10990	8000	10000	78,5	98,1	6400	7000	12,5	11,3
V8013	VV141B/8	SA	-	▲	18254	15385	11500	14000	113	137	8700	9100	19,9	18,5
V8014	VV171B/8	SA	-	▲	21430	19010	13500	17300	132	170	9800	10500	20,8	18,9
V8015	VV221B/8	TA	-	▲	28890	24725	18200	22500	179	221	11800	15900	25,1	27,2
V8030	VV261B/8	TA	-	▲	-	28890	-	26300	-	258	-	15900	-	27,2

▲ Certificazione CSA disponibile su richiesta, con cavo di alimentazione incluso / CSA certification on request, power supply cable included

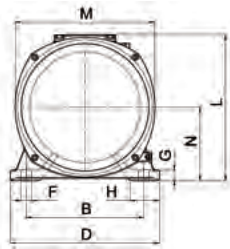

Ref.3

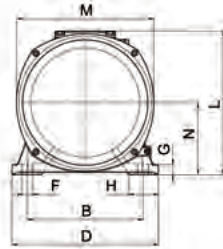
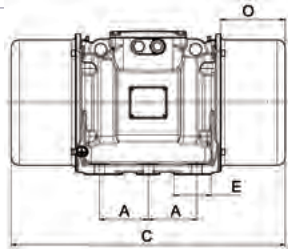

Ref.4

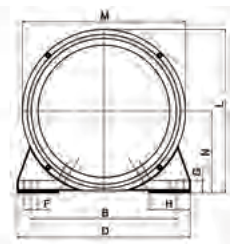
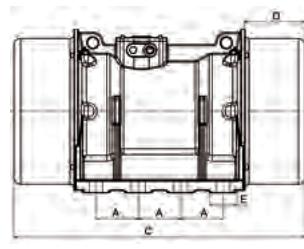

Dimensioni (mm) – Dimensional Specifications (mm)

Peso Weight (kg.)		Ref.	Distanze di Fissaggio Fixing distances					Fori Fissaggio Fixing holes		G	H	L	M	N	O	Pressacavo Cable gland
50Hz	60Hz		A	B	C	D	E	ØF	N°							
19	19	1	105	140	340	167	38	13	4	30	31	203	160	82,5	91	M25x1,5
27	27	1	120	170	382	205	47	17	4	45	37,5	211	182	93,5	100	M25x1,5
36	36	1	120	170	436	205	42	17	4	42	40	224	203	104,5	118	M25x1,5
48	48	1	140	190	490	230	50	17	4	45	45	244	225	116	129	M25x1,5
57	57	1	140	190	560	230	50	17	4	45	45	244	225	116	164	M25x1,5
82	82	1	155	225	600	275	55	22	4	70	55	272	253	130	169	M25x1,5
93	93	1	155	225	655	275	55	22	4	70	55	272	253	130	196	M25x1,5
133	133	2	155	255	657	315	81	23,5	4	22	63	309	295	155	173,5	M25x1,5
201	201	2	180	280	730	345	99	26	4	28	77,5	346	320	165	200	M32x1,5
217	217	2	180	280	790	345	99	26	4	28	77,5	346	320	165	230	M32x1,5
242	242	2	200	320	735	380	106	28	4	28	80	364	356	183	187,5	M32x1,5
267	267	2	200	320	826	380	106	28	4	28	80	364	356	183	233	M32x1,5
320	320	2	200	320	854	390	106	28	4	30	95	392	378	192	247	M32x1,5
333	333	2	125	380	862	460	76	39	6	35	107,5	431	414	215	230	M32x1,5
441	422	3	125	380	1002	460	76	39	6	35	107,5	431	414	215	300	M32x1,5
698	676	4	140	480	1040	570	90	45	8	41	135	537	538	268	240	M32x1,5
750	711	4	140	480	1120	570	90	45	8	41	135	537	538	268	280	M32x1,5
1010	975	4	140	520	1150	610	90	45	8	38	145	612	594	297	298	M32x1,5
-	1010	4	140	520	1150	610	90	45	8	38	145	612	594	297	298	M32x1,5



Motovibratori per atmosfere potenzialmente esplosive

Zone d'uso

1,2 (GAS) 21,22 (POLVERI)

Alimentazione

- Tensione trifase da 120 a 690V a 50Hz o 60Hz.
- Tropicalizzazione standard su tutta la gamma.
- Protezione dello statore con impregnazione sotto vuoto fino alla grandezza GA e goccia a goccia per le grandezze superiori.
- Classe di isolamento F (155°C).
- Idonei al funzionamento con variatore di frequenza in presenza di termistore. Regolazione da 20Hz fino alla frequenza di targa a coppia costante.
- Termistore PTC 130°C a richiesta fino alla grandezza LA, di serie dalla grandezza MA. A richiesta scaldiglie anti condensa.

Funzionamento

- Temperatura di funzionamento da -20°C a + 40°C (su richiesta +55°C).
- Progettati per il funzionamento in continuo (S1) al 100% della forza centrifuga.
- Protezione meccanica IP 66.
- Controllo sul 100% dei componenti.



CESI

Product Quality Assurance
Notification CESI 02 ATEX 112Q
Quality Assessment Report IT/
CES/QAR20.0004



VV-E
II2D II2G (2014/34/UE)
Ex tb IIIC T...°C Db
Ex e IIC T3/T4 Gb
EN 60079-0, EN 60079-7, EN 60079-31
Electric vibrators for gas and dust
explosive atmospheres
Cert. N. LCIE07ATEX6032X

2 POLI 3000/3600 giri – 2 POLES 3000/3600 rpm

Codice Code	Tipo Type	Grand. Size	Ex		Potenza MAX INPUT POWER (W)		Potenza resa Power Rating (W)		Corrente Max assorbita (A) Max. Input Current		tE (s)	IA/IN
			Temp. Class (G)	Temp. Class (D)	50Hz	60Hz	50Hz	60Hz	400V 50Hz	460V 60Hz		
V2E21	VV03N/2-E*	BA	T3	120°C	180	180	120	120	0,33	0,30	30	2,68
			T4	105	105	80	80	0,26	0,23	20	3,48	
V2E22	VV05N/2-E*	BA	T3	120°C	180	180	120	120	0,33	0,30	30	2,68
			T4	260	270	210	210	0,57	0,50	18	3,5	
V2E23	VV10N/2-E	CA	T3	120°C	230	230	172	172	0,48	0,41	12	4,2
			T4	500	500	300	300	0,76	0,67	12	4,2	
V2E17	VV15N/2-E	DA	T3	120°C	350	360	210	210	0,57	0,50	8	5,6
			T4	550	570	405	405	0,95	0,83	12	4,2	
V2E20	VV25N/2-E	EA	T3	120°C	390	400	290	290	0,72	0,64	8	5,52
			T4	550	600	350	350	0,86	0,75	15	3,88	
V2E24	VV35N/2-E	GA	T3	120°C	460	500	290	290	0,76	0,67	11	4,37
			T4	1010	1070	720	720	1,62	1,40	6	9,29	
V2E25	VV38N/2-E	HA	T3	200°C	830	910	660	660	1,43	1,25	6	7,3
			T4	1110	1150	960	960	1,90	1,66	7	5,9	
V2E07	VV40N/2-E	IB	T3	200°C								

* Disponibile solo nella tensione 127/220V 50Hz, 200/346V 50Hz, 210/363V 60Hz

Electric vibrators for hazardous locations

Working environment

1,2 GAS 21 22 DUST

Power Supply

- Three-phase 230/400V 50Hz. On request three-phase from 42 to 690V 50/60Hz.
- Tropicalization standard on all vibrators.
- Winding insulation with vacuum encapsulating up to GA size included, drop by drop system from HA size
- Insulation class F (155°C).
- Suitable for operation with inverter (VFD) with thermistor from 20Hz up to the rated frequency with constant torque load.
- Thermistor PTC 130°C at request up to size LA, standard from size MA. On request anti - condensation heater.

Functioning

- Working temperature from -20°C a + 40°C (on request +55°C).
- Designed for continuous duty (S1) with 100% centrifugal force CF.
- Standard mechanical protection IP 66.
- 100% components tested.

4 POLI 1500/1800 giri – 4 POLES 1500/1800 rpm												
Codice Code	Tipo Type	Grand. Size	Temp. Class (G)	Temp. Class (D)	Potenza MAX INPUT POWER (W)		Potenza resa Power Rating (W)		Corrente Max assorbita (A) Max. Input Current		tE (s)	IA/IN
					50Hz	60Hz	50Hz	60Hz	400V 50Hz	460V 60Hz		
V4E24	VV10B/4-E	CA	T4	120°C	170	175	94	95	0,39	0,40	28	2,34
V4E25	VV20B/4-E	DA	T3	120°C	300	320	200	230	0,57	0,52	18	3,33
			T4		285	270	180	200	0,52	0,46	16	3,63
V4E15	VV21B/4-E	DA	T3	120°C	300	320	200	230	0,57	0,52	18	3,33
			T4		285	270	180	200	0,52	0,46	16	3,63
V4E30	VV30B/4-E	EA	T3	120°C	460	500	310	380	0,86	0,85	17	3,50
			T4		360	420	240	310	0,72	0,70	12	4,20
V4E31	VV35B/4-E	GA	T4	120°C	370	450	285	340	0,81	0,83	13	4
V4E06	VV38B/4-E	HA	T3	120°C	900	950	660	730	1,38	1,32	13	4
			T4		630	700	460	505	1,05	1,00	8	5,36
V4E07	VV40B/4-E	IA	T3	150°C	1100	1150	730	800	1,90	1,82	9	4,95
			T4		630	700	480	530	1,33	1,27	5,5	7
V4E16	VV41B/4-E	IA	T3	150°C	1100	1150	730	800	1,90	1,82	9	4,95
			T4		630	700	480	530	1,33	1,27	5,5	7
V4E08	VV50B/4-E	LA	T3	150°C	1600	1700	1340	1470	3,04	3,20	7	6
			T4		1150	1250	880	970	2,47	2,30	5,5	7,5
V4E17	VV53B/4-E	LA	T3	135°C	1280	1550	1000	1200	3,14	3,10	5,5	7,42
			T4		1150	1400	900	1080	2,85	2,85	5,5	8,16
V4E09	VV55B/4-E	MA	T3	135°C	2200	2400	1780	1960	3,71	3,50	6	7,17
			T4		1850	1950	1500	1650	3,14	3,00	6	8,42
V4E18	VV57B/4-E	MA	T3	135°C	2200	2400	1780	1960	3,71	3,50	6	7,17
			T4		1850	1950	1500	1650	3,14	3,00	6	8,42
V4E10	VV60B/4-E	NA	T3	135°C	3200	3700	2560	2800	5,70	5,45	6	7
V4E33	VV62B/4-E	NA	T3	135°C	3200	3700	2560	2800	5,70	5,45	6	7
V4E13	VV81B/4-E	QA	T3	135°C	7300	7900	5925	6500	11,6	11,0	5,5	7

6 POLI 1000/1200 giri – 6 POLES 1000/1200 rpm												
Codice Code	Tipo Type	Grand. Size	Temp. Class (G)	Temp. Class (D)	Potenza MAX INPUT POWER (W)		Potenza resa Power Rating (W)		Corrente Max assorbita (A) Max. Input Current		tE (s)	IA/IN
					50Hz	60Hz	50Hz	60Hz	400V 50Hz	460V 60Hz		
V6E35	VV30B/6-E	EA	T4	120°C	320	350	201	221	0,67	0,65	25	2,81
V6E36	VV35B/6-E	GA	T4	120°C	350	380	240	264	0,71	0,68	26	2,4
V6E37	VV38B/6-E	HA	T3	135°C	680	730	448	490	1,33	1,27	25	2,78
			T4		500	540	290	320	1,05	1,00	17	3,54
V6E38	VV40B/6-E	IA	T3	135°C	750	690	550	550	1,57	1,36	19	3,33
			T4		480	500	300	300	1,24	1,00	13	4,23
V6E39	VV41B/6-E	IA	T3	135°C	750	690	550	550	1,57	1,36	19	3,33
			T4		480	500	300	300	1,24	1,00	13	4,23
V6E40	VV50B/6-E	LA	T3	135°C	1100	1200	825	900	2,09	2,00	15	3,63
			T4		850	950	615	675	1,81	1,70	10	4,73
V6E06	VV55B/6-E	MA	T3	135°C	1960	2100	1580	1700	3,90	3,70	8	5,31
V6E20	VV57B/6-E	MA	T3	135°C	2200	2400	1630	1770	4,28	4,3	8	4,82
			T4		1770	1900	1350	1470	3,71	3,6	5	5,56
V6E07	VV60B/6-E	NA	T3	135°C	2200	2700	1575	1730	4,85	4,60	7	5,88
			T4		2000	2200	1500	1650	4,28	4,00	6	6,66
V6E21	VV62B/6-E	NA	T3	135°C	3100	3500	2500	2770	6,18	6	10	5,23
			T4		2550	3000	2100	2290	5,42	5,2	6	5,96
V6E08	VV65B/6-E	OA	T3	135°C	3500	3650	2590	2700	6,65	6,10	10	4,64
V6E42	VV66B/6-E	OA	T3	135°C	3500	3650	2590	2700	6,65	6,10	10	4,64
V6E12	VV81B/6-E	QA	T3	135°C	5400	5900	4500	4800	9,98	9,10	7	6

8 POLI 750/900 giri – 8 POLES 750/900 rpm												
Codice Code	Tipo Type	Grand. Size	Temp. Class (G)	Temp. Class (D)	Potenza MAX INPUT POWER (W)		Potenza resa Power Rating (W)		Corrente Max assorbita (A) Max. Input Current		tE (s)	IA/IN
					50Hz	60Hz	50Hz	60Hz	400V 50Hz	460V 60Hz		
V8E19	VV20B/8-E	DA	T3	130°C	230	250	100	110	0,67	0,64	25	2
V8E23	VV30B/8-E	EA	T3	130°C	350	350	190	205	0,86	0,80	25	2,47
V8E24	VV35B/8-E	GA	T4	120°C	280	300	135	150	0,57	0,56	30	1,66
V8E25	VV38B/8-E	HA	T3	120°C	500	525	275	302	1,14	1,10	30	2,15
			T4		600	670	336	380	1,33	1,30	30	2,14
V8E26	VV40B/8-E	IA	T3	120°C	450	500	225	255	1,14	1,10	25	2,5
			T4		450	500	225	255	1,14	1,10	25	2,5
V8E27	VV50B/8-E	LA	T3	150°C	950	1100	646	740	2,09	2,10	30	2,63
V8E06	VV55B/8-E	MA	T3	135°C	1500	1650	1065	1225	3,61	3,60	15	4,18
V8E07	VV60B/8-E	NA	T3	135°C	2000	2200	1460	1600	5,13	5,00	13	3,96
V8E16	VV62B/8-E	NA	T3	135°C	2630	2990	1900	2180	6,18	6,20	14	3,84
V8E08	VV65B/8-E	OA	T3	135°C	2630	2990	1900	2180	6,18	6,20	14	3,84
V8E09	VV67B/8-E	OA	T3	135°C	3520	3800	2570	2775	7,79	7,40	14	3,8
V8E11	VV81B/8-E	QA	T3	135°C	5100	5800	4100	4500	11,4	11,0	17	3,5

* Available only in 127/220V 50Hz, 200/346V 50Hz, 210/363V 60Hz voltage.



Motovibratori per atmosfere potenzialmente esplosive

Motovibratori elettrici Classe I Divisione 2 conformi ai requisiti delle Norme CSA.

Norme e requisiti applicabili:

- CAN/CSA - C22.2 N°100-95, Motori e Generatori.

- Electrical notice 672.

Classe 4228 01 – Motori e Generatori - per atmosfere potenzialmente esplosive.

Classe I, Divisione 2, Gruppi A, B, C e D.
Classe di temperatura T3C.

Caratteristiche tecniche

- Le caratteristiche meccaniche (momento statico, forza centrifuga, peso e dimensioni) corrispondono a quelle della serie VV standard (pagg. 6-13)
- Forniti senza il pressacavo e con un adattatore speciale con uscita a filetto NPT
- Tensione di alimentazione massima di 600V

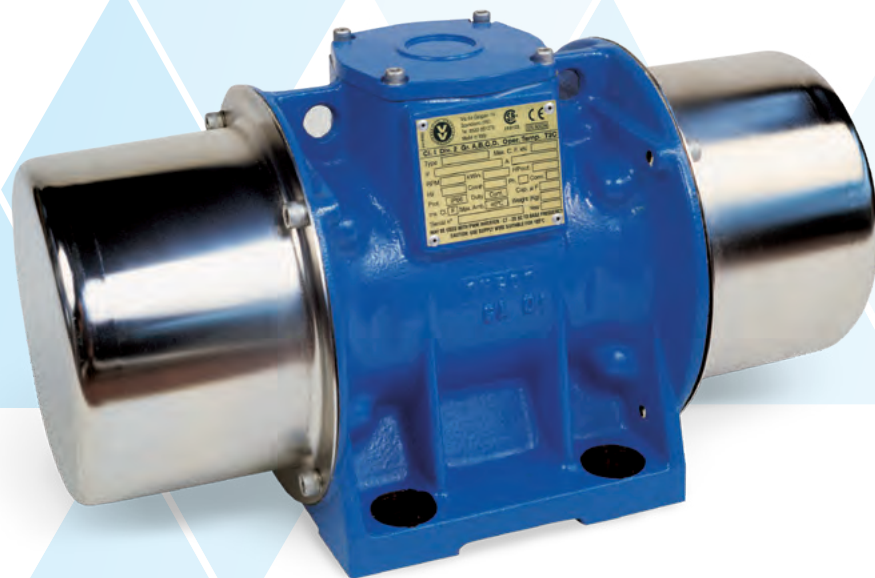

VV-C
Hazardous locations
Class I, Div. 2, Groups ABCD
CAN/CSA C22.2 No. 145-M1986
Electr. Notice 672
Certificate 1324136

2 POLI 3000/3600 giri - 2 POLES 3000/3600 rpm

Codice Code	Tipo Type	Grand Size	Potenza Resa Massima (Hp) Max Output Power Rating (Hp)		Corrente Max assorbita (A) Max. Input Current		Ia/In		Filetto per pressacavo Thread for cable gland
			50Hz	60Hz	400V 50Hz	460V 60Hz	50Hz	60Hz	
V2C21	VV03N/2-C	BA	0,18	0,18	0,33	0,29	2,7	3,0	NPT 1/2"
V2C22	VV05N/2-C	BA	0,18	0,18	0,33	0,29	2,7	3,0	NPT 1/2"
V2C23	VV10N/2-C	CA	0,26	0,26	0,57	0,48	3,5	4,2	NPT 1/2"
V2C17	VV15N/2-C	DA	0,53	0,53	0,76	0,71	4,2	4,8	NPT 1/2"
V2C26	VV22N/2-C	DA	0,53	0,53	0,76	0,71	4,2	4,8	NPT 1/2"
V2C20	VV25N/2-C	EA	0,71	0,71	1,00	0,95	3,8	6,0	NPT 1/2"
V2C24	VV35N/2-C	GA	1,80	1,80	1,60	1,60	3,6	4,0	NPT 1/2"
V2C25	VV38N/2-C	HA	2,20	2,20	3,20	2,80	4,3	5,5	NPT 1/2"
V2C27	VV39N/2-C	HA	2,20	2,20	3,20	2,80	4,3	5,5	NPT 1/2"
V2C28	VV39,5N/2-C	IB	2,20	2,20	3,40	2,90	4,60	6,00	NPT 1/2"
V2C07	VV40N/2-C	IB	2,20	2,20	3,40	2,90	4,6	6,0	NPT 1/2"
V2C08	VV45N/2-C	MA	4,60	4,60	6,20	5,40	4,5	5,2	NPT 3/4"
V2C09	VV55N/2-C	MA	4,60	4,60	6,20	5,40	4,5	5,2	NPT 3/4"
V2C13	VV67N/2-C	OA	6,50	6,50	8,80	7,70	6,5	7,2	NPT 3/4"

Monofase Single-phase	Codice Code	Tipo Type	Grand Size	Potenza Resa Massima (Hp) Max Output Power Rating (Hp)		Corrente Max assorbita (A) Max. Input Current		Ia/In		Filetto per pressacavo Thread for cable gland
				50Hz	60Hz	230V 50Hz	115V 60Hz	50Hz	60Hz	
V2C21	VV03N/2-C	BA	0,14	0,14	0,70	1,50	1,7	2,2	NPT 1/2"	
V2C22	VV05N/2-C	BA	0,14	0,14	0,70	1,50	1,7	2,2	NPT 1/2"	
V2C23	VV10N/2-C	CA	0,27	0,27	1,20	2,30	2,5	3,5	NPT 1/2"	
V2C17	VV15N/2-C	DA	0,48	0,48	2,20	4,20	3,4	4,2	NPT 1/2"	
V2C26	VV22N/2-C	DA	0,48	0,48	2,20	4,20	3,4	4,2	NPT 1/2"	
V2C20	VV25N/2-C	EA	0,68	0,68	3,10	6,50	4,0	4,1	NPT 1/2"	

Electric vibrators for hazardous locations

Electric vibrators Class I Division 2 in compliance to the CSA Standards.

Applicable requirements:

- CAN/CSA - C22.2 No. 100-95, Motors and Generators
- Electrical Notice 672.

Class 4228 01 – Motors and Generators - For Hazardous Locations.

Class I, Division 2, Groups A, B, C and D. Temperature Class T3C.

Technical features

- Mechanical features (static moment, centrifugal force, weight and dimensions) are the same of standard VV series (pages 6-13)
- Supplied without cable gland but with a special adapter with NPT output thread
- 600 V maximum power supply voltage

4 POLI 1500/1800 giri – 4 POLES 1500/1800 rpm

Codice Code	Tipo Type	Grand Size	Potenza Resa Massima (Hp) Max Output Power Rating (Hp)		Corrente Max assorbita (A) Max. Input Current		Ia/In		Filetto per pressacavo Thread for cable gland
			50Hz	60Hz	400V 50Hz	460V 60Hz	50Hz	60Hz	
V4C21	VV03B/4-C	BA	0,06	0,06	0,20	0,19	1,8	2,0	NPT 1/2"
V4C22	VV05B/4-C	BA	0,06	0,06	0,20	0,19	1,8	2,0	NPT 1/2"
V4C23	VV06B/4-C	BA	0,06	0,06	0,20	0,19	1,8	2,0	NPT 1/2"
V4C24	VV10B/4-C	CA	0,13	0,13	0,38	0,38	2,3	2,8	NPT 1/2"
V4C25	VV20B/4-C	DA	0,40	0,40	0,57	0,57	3,3	3,5	NPT 1/2"
V4C15	VV21B/4-C	DA	0,40	0,40	0,57	0,57	3,3	3,5	NPT 1/2"
V4C30	VV30B/4-C	EA	0,70	0,70	0,88	0,93	3,5	3,4	NPT 1/2"
V4C32	VV32B/4-C	EA	0,70	0,70	0,88	0,93	3,5	3,4	NPT 1/2"
V4C31	VV35B/4-C	GA	0,80	0,80	0,90	0,90	4,5	4,9	NPT 1/2"
V4C06	VV38B/4-C	HA	1,20	1,20	1,37	1,43	4,1	4,2	NPT 1/2"
V4C07	VV40B/4-C	IA	1,25	1,25	1,91	1,83	4,3	4,9	NPT 1/2"
V4C16	VV41B/4-C	IA	1,25	1,25	2,40	2,20	3,4	4,1	NPT 1/2"
V4C08	VV50B/4-C	LA	2,30	2,30	3,00	2,90	6,1	7,2	NPT 1/2"
V4C17	VV53B/4-C	LA	2,30	2,30	3,60	3,30	6,5	7,5	NPT 1/2"
V4C09	VV55B/4-C	MA	3,30	3,30	3,80	3,70	7,1	6,9	NPT 3/4"
V4C18	VV57B/4-C	MA	3,30	3,30	4,60	4,40	5,9	7,1	NPT 3/4"
V4C10	VV60B/4-C	NA	3,60	3,60	5,70	4,80	7,0	8,0	NPT 3/4"
V4C33	VV62B/4-C	NA	3,60	3,60	5,70	4,80	7,0	8,0	NPT 3/4"
V4C11	VV67B/4-C	OA	7,00	7,00	10,0	8,60	6,5	7,7	NPT 1/2"
					230V 50Hz	115V 60Hz			

Monofase Single-phase	4 POLI 1500/1800 giri – 4 POLES 1500/1800 rpm									
	V4C21	VV03B/4-C	BA	-	0,06	-	0,90	-	1,3	NPT 1/2"
	V4C22	VV05B/4-C	BA	-	0,06	-	0,90	-	1,3	NPT 1/2"
	V4C24	VV10B/4-C	CA	0,17	0,17	0,95	1,91	1,5	1,9	NPT 1/2"
	V4C25	VV20B/4-C	DA	-	0,26	-	2,60	-	2,2	NPT 1/2"
	V4C30	VV30B/4-C	EA	0,45	0,45	2,0	4,90	5,4	3,6	NPT 1/2"

6 POLI 1000/1200 giri – 6 POLES 1000/1200 rpm

V6C29	VV20B/6-C	DA	0,20	0,20	0,48	0,48	2,7	3,1	NPT 1/2"
V6C35	VV30B/6-C	EA	0,40	0,40	0,68	0,65	2,6	2,8	NPT 1/2"
V6C36	VV35B/6-C	GA	0,50	0,50	0,71	0,65	2,5	3,7	NPT 1/2"
V6C37	VV38B/6-C	HA	0,70	0,70	1,30	1,30	2,8	3,3	NPT 1/2"
V6C38	VV40B/6-C	IA	0,90	0,90	1,60	1,30	3,3	4,1	NPT 1/2"
V6C39	VV41B/6-C	IA	0,90	0,90	2,00	1,90	3,6	4,3	NPT 1/2"
V6C40	VV50B/6-C	LA	1,70	1,70	2,10	2,10	4,2	4,1	NPT 1/2"
V6C41	VV53B/6-C	LA	1,70	1,70	2,80	2,70	4,5	4,2	NPT 1/2"
V6C06	VV55B/6-C	MA	2,70	2,70	3,90	3,60	5,4	5,6	NPT 3/4"
V6C20	VV57B/6-C	MA	2,70	2,70	4,30	4,10	4,4	4,8	NPT 3/4"
V6C07	VV60B/6-C	NA	3,90	3,90	4,80	4,70	5,9	6	NPT 3/4"
V6C21	VV62B/6-C	NA	3,90	3,90	6,30	5,80	5,2	5,5	NPT 3/4"
V6C08	VV65B/6-C	OA	4,70	4,70	6,70	6,20	4,7	5,1	NPT 3/4"
V6C42	VV66B/6-C	OA	4,70	4,70	6,70	6,20	4,7	5,1	NPT 3/4"
V6C09	VV67B/6-C	OA	4,70	4,70	7,70	7,60	4,5	5,8	NPT 3/4"
V6C43	VV69B/6-C	OA	4,70	4,70	7,70	7,60	4,5	5,8	NPT 3/4"

8 POLI 750/900 giri – 8 POLES 750/900 rpm

V8C19	VV20B/8-C	DA	0,17	0,17	0,80	0,71	2,1	2,1	NPT 1/2"
V8C23	VV30B/8-C	EA	0,30	0,30	1,00	1,00	2,0	2,3	NPT 1/2"
V8C24	VV35B/8-C	GA	0,35	0,35	0,57	0,55	1,7	2,5	NPT 1/2"
V8C25	VV38B/8-C	HA	0,40	0,40	1,10	1,10	2,4	2,5	NPT 1/2"
V8C26	VV40B/8-C	IA	0,41	0,41	1,30	1,20	2,4	2,8	NPT 1/2"
V8C27	VV50B/8-C	LA	1,10	1,10	2,10	2,10	2,6	3,4	NPT 1/2"
V8C28	VV53B/8-C	LA	1,10	1,10	2,50	2,50	2,8	3,0	NPT 1/2"
V8C06	VV55B/8-C	MA	1,80	1,80	3,60	3,70	3,6	3,0	NPT 3/4"
V8C07	VV60B/8-C	NA	3,00	3,00	5,10	5,00	4,0	4,6	NPT 3/4"
V8C16	VV62B/8-C	NA	3,00	3,00	5,80	5,80	4,0	4,2	NPT 3/4"
V8C08	VV65B/8-C	OA	4,30	4,30	6,20	6,20	3,8	4,0	NPT 3/4"
V8C09	VV67B/8-C	OA	4,30	4,30	7,70	7,40	3,8	5,3	NPT 3/4"



VV MICRO



II 3D, Ex tc III C T 100°C Dc IP65,
EN 60079-0, EN 60079-31

Micro

Descrizione Description				Caratteristiche Elettriche Electrical Specifications									
Codice Code	Tipo Type	 II 3D Temp. Class	Momento Statico Static Moment		Forza Centrifuga Centrifugal Force				Potenza assorbita Max Max. Input Power		Corrente Max (A) Max. Input Current (A)		
			kgmm		kg		N		(W)				
			50Hz	60Hz	50Hz	60Hz	50Hz	60Hz	50Hz	60Hz	220V 50Hz	115V 60Hz	
Monofase Single Phase	V2014	VV000N/2	100°C	0,4	0,4	4	6	39	59	24	24	0,13	0,30
	V2015	VV001N/2	100°C	2,0	2,0	20	30	196	284	35	35	0,17	0,42
	V2016	VV002N/2	100°C	4,5	4,5	45	65	441	638	45	45	0,20	0,46
Trifase Three-phase	V2015	VV001N/2	100°C	2,0	2,0	20	30	196	284	35	35	400-480V 50/60HZ	
	V2016	VV002N/2	100°C	4,5	4,5	45	65	441	638	45	45	0,16	

Caratteristiche generali

VV000N/2

Monofase 220 - 240V 50/60Hz, 100 - 130V 50/60Hz oppure 24V 50/60Hz con cavo di alimentazione incluso.

VV001N/2 VV002N/2

Monofase 220 - 240V 50/60Hz 100 - 130V 50/60 Hz con cavo di alimentazione e condensatore inclusi, trifase da 24 a 460V 50/60Hz con cavo di alimentazione.

- Temperatura di esercizio -20°C +40°C
- Classe di isolamento F (135°C)
- Progettati per servizio continuo (S1) al 100% della forza centrifuga
- Protezione meccanica IP 65
- Corpo motore in alluminio, coperchi masse in acciaio inox AISI 304
- Idoneo per il funzionamento in atmosfere di polveri potenzialmente esplosive secondo la direttiva ATEX 2014/34/UE, categoria II3D, • Ex tc III C T 100°C Dc IP 65 Classe di temperatura 100°C zona 22.

General features

VV000N/2

Available only single phase 220 - 240V 50/60Hz, 100 - 130V 50/60Hz or 24V 50/60Hz with power supply cable included.

VV001N/2 VV002N/2

Available single phase 220V - 240V 50/60Hz or 100 - 130V 50/60Hz with power supply cable and capacitor included and threephase from 24 to 460V 50/60 Hz with power supply cable included.

- Operating temperature -20°C +40°C
- Insulation Class F (135°C)
- Designed for continuous duty (S1) with 100% centrifugal force.
- Mechanical protection IP 65
- Motor casing in aluminium, weight covers in stainless steel AISI 304
- All Micro operates in compliance with ATEX 2014/34/UE for use in potentially Explosive Atmospheres category II3D, Ex tc III C T 100°C Dc IP 65 Temperature class 100°C, Zone 22.

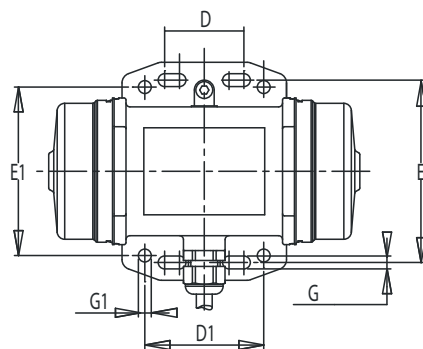
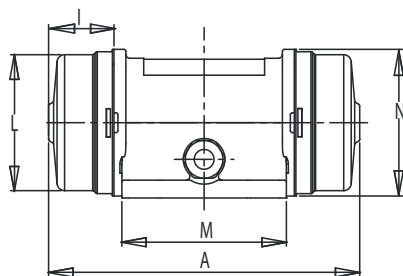
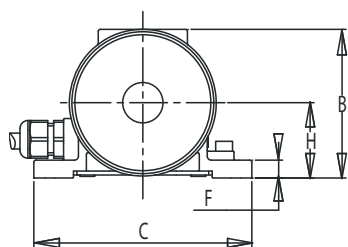

Dimensioni (mm)
Dimensional Specification (mm)

Peso Weight (kg.)	Fori Fissaggio Fixing holes																
	60Hz	A	B	C	D	D1	E	E1	ØG	G	N°	H	I	L	M	N	Pressacavo Cable gland
50Hz	60Hz																
0,92	0,92	113	66,5	90	25-40	-	75	-	-	5,5	4	34	25	60	59	65	M12X1,5
1,97	1,97	157	75	110	25-40	60	92	85	6,5	6,5	8	38	33	69	83	74	M16X1,5
2,20	2,20	172	75	110	25-40	60	92	85	6,5	6,5	8	38	40,5	69	83	74	M16X1,5
1,97	1,97	157	75	110	25-40	60	92	85	6,5	6,5	8	38	33	69	83	74	M16X1,5
2,20	2,20	172	75	110	25-40	60	92	85	6,5	6,5	8	38	40,5	69	83	74	M16X1,5

VV01N/2



Alimentazione

- Standard trifase 230/400V a 50Hz. A richiesta trifase da 42 a 690V a 50/60Hz. Disponibile nella versione monofase 100-130V a 60Hz e 200-240V 50Hz condensatore escluso.
- Disponibile solo a 2 poli
- Tropicalizzazione standard e protezione dello statore con trattamento sottovuoto
- Classe di isolamento F (155°c)
- Idonei al funzionamento con variatore di frequenza. Regolazione da 20Hz fino alla frequenza di targa a coppia costante.
- A richiesta termistore PTC 130°C

Funzionamento

- Temperatura di funzionamento da -20°C a + 40°C (a richiesta +55° C)
- Progettati per il funzionamento in continuo (S1) al 100% della forza centrifuga
- Protezione meccanica IP 66
- Fissaggio multiforo

Caratteristiche meccaniche

- Corpo motore in lega leggera di alluminio, coperchi masse in alluminio
- Sistema di regolazione masse.

Power Supply

- Standard three-phase 230/400V 50Hz. On request three-phase from 42 to 690V 50/60Hz. Available single phase 100-130V a 60Hz and 200-240V 50Hz capacitor excluded
- Only 2 poles available
- Tropicalization standard winding insulation with vacuum incapsulating
- Insulation class F (155°C)
- Suitable for operation with inverter (VFD) from 20Hz up to the rated frequency with constant torque load.
- Thermistor PTC 130°C on request up to size LA, standard from size MA

Functioning

- Working temperature from -20°C a + 40°C (on request +55° C)
- Designed for continuous duty (S1) with 100% centrifugal force CF
- Standard mechanical protection IP 66
- Multi holes fixing base

Mechanical features

- Motor casing in high tensile aluminium alloy, weight covers in aluminium alloy
- Eccentric weights regulation system.



VV
Ordinary locations
Class 4211 01 - Motors and
generators
CAN/CSA C22.2 - No. 100-95
UL 1004-1
Certificate 1324136

VV
II2D (2014/34/UE)
Ex tb IIIC T...°C Db
EN 60079-0, EN 60079-31
Electric vibrators for dust
explosive atmospheres
Cert. N.
LCIE07ATEX6014X



VV
Ex tb IIIC T...°C Db
IEC 60079-0, IEC
60079-31
Electric vibrators
for dust explosive
atmospheres
Cert. IECEx LCIE
21.0020X

VV
Ex tb IIIC T...°C Db
EN IEC 60079-0, EN
60079-31
Electric vibrators for dust
explosive atmospheres
Regulations 2016, UKSI
2016:1107 amended by
UKSI 2019 No.696

Product Quality
Assurance Notification
CESI 02 ATEX 112Q
Quality Assessment
Report IT/CES/
QAR20.0004

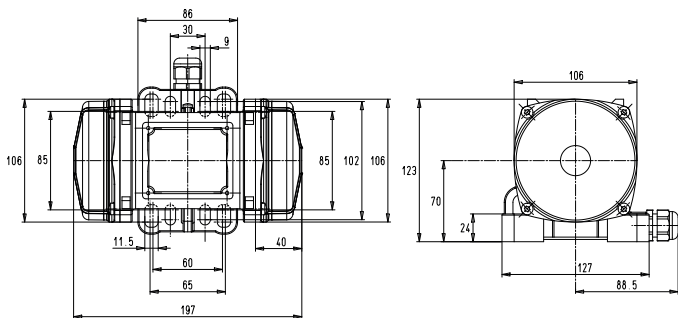

Descrizione Description			Caratteristiche Meccaniche Mechanical Specifications				Caratteristiche Elettriche Electrical Specifications				Dimensioni Dimensional Specification				
Codice Code	Tipo Type	Ex II 2 D Temp. Class	Momento Statico Static Moment		Forza Centrifuga Centrifugal Force				Potenza assorbita Max Max. Input Power		Corrente Max (A) Max. Input Current (A)		Peso Weight		
			kgmm	kgmm	kg	kg	kN	kN	50Hz	60Hz	50Hz	60Hz	50Hz	60Hz	(kg.)
V2018	VV01N/2	120°C	6,43	6,43	65	93	0,638	0,912	120	120	0,27	0,23	4,3	4,3	
Monofase / Single Phase												220V 50Hz	115V 60Hz		
V2018	VV01N/2	120°C	6,43	6,43	65	93	0,638	0,912	110	110	0,56	1,52	4,3	4,3	

VVCC



Ref.1

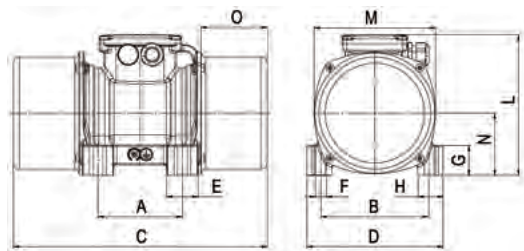

Caratteristiche tecniche

- Alimentazione in corrente continua a 12 o 24 V a 3000 rpm
- Motore asincrono trifase con avvolgimento isolato sotto vuoto e alimentato in corrente continua tramite scheda inclusa nel motovibratore
- Tropicalizzazione standard e protezione dello statore con trattamento sottovuoto
- Fornito con cavo di alimentazione di 2,5 mt
- Protezione meccanica IP 66
- Temperatura di funzionamento da -20°C a + 40°C (su richiesta +55°C)
- Progettati per il funzionamento in continuo (S1) o intermittente al 100% della forza centrifuga

Technical Features

- Power supply in DC current 12 or 24 V
- Asynchronous three-phase motor type with vacuum insulated winding. Supplied in direct current by means of an electronic card included in the vibrator.
- Tropicalization standard winding insulation with vacuum encapsulating
- Supplied with 2,5 mt cable
- Standard mechanical protection IP 66
- Working temperature from -20°C a + 40°C (on request +55°C)
- Designed for continuous (S1) or intermittent duty with 100% centrifugal force CF

Descrizione Description		Caratteristiche Meccaniche Mechanical Specifications				Caratteristiche Elettriche Electrical Specifications		Dimensioni (mm) Dimensional Specification (mm)																		
Codice Code	Tipo Type	Momento Statico Static Moment		Forza Centrifuga Centrifugal Force		Potenza assorbita Max. Input Power (W)	Corrente Max (A) Max. Input Current (A)		Peso Weight (kg.)	Ref.	Distanze di Fissaggio Fixing distances					Fori Fissaggio Fixing holes		Pressacavo Cable gland								
		kgmm		kg	kN		12 V	24 V			A	B	C	D	E	ØF	N°		G	H	L	M	N	O		
V2046	VVCC03N/2	12	12	120	175	1,18	1,72	190	8,00	4,00	5,6	1	62-74	106	209	125	30	9	4	22	22,5	150	117	61	45	M20x1,5
V2047	VVCC05N/2	20	15	205	214	2,01	2,10	190	8,00	4,00	6,2	1	62-74	106	225	125	30	9	4	22	22,5	150	117	61	53	M20x1,5



Caratteristiche tecniche generali

- Momento statico da 3140 a 119525 kgmm.
- Possibilità di regolazione del momento statico attraverso l'aggiunta di masselli in acciaio o piombo.
- Forza centrifuga da 63kN a 632 kN.
- Temperatura ambiente da -40°C a +70°C.
- Montaggio oscillatore VMD in qualsiasi posizione, sempre con alberi in allineamento orizzontale.
- Carcassa in ghisa sferoidale.
- Lubrificazione ingranaggi e cuscinetti per immersione in olio e per esposizione a nebbia d'olio.
- Cuscinetti radiali orientabili a due corone di punti. Durata superiore alle 40000 ore in condizioni di massimo carico.

Il modello VMD viene fornito completo di flangia di accoppiamento (a norme DIN), carter di protezione e masselli (acciaio o piombo) a seconda della configurazione richiesta.

Possibilità di fornitura di tutto il sistema di azionamento così come di interessi di foratura diversi.

Per maggiori informazioni di carattere tecnico applicativo vi invitiamo a consultare il manuale d'uso e manutenzione.

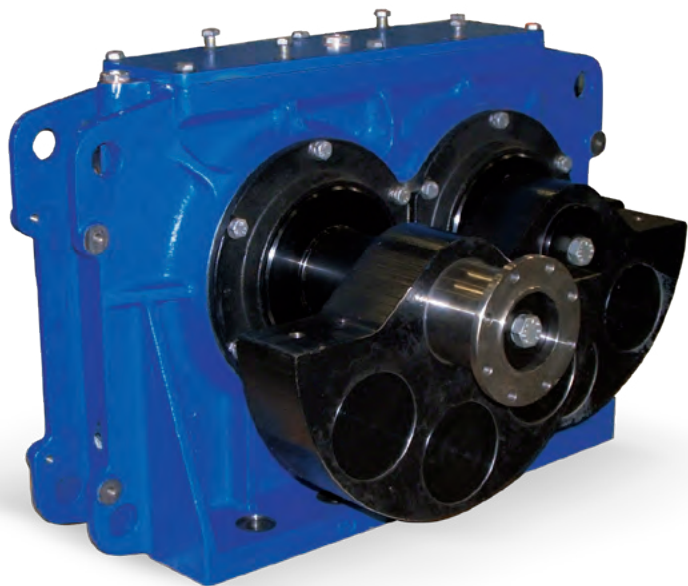

Descrizione – Description			Caratteristiche Elettriche – Electrical Specifications					
Grandezza Size	Codice Code	Tipo Type	Configurazione masse Weight setting	Momento Statico Static Moment kgmm	Max RPM	Forza Centrifuga Centrifugal Force kN	Peso Weight kg	Potenza Motore Azionamento Driving Motor Rating kW
270	VV00008	VMD 5000/6	Min	3140	1348	63	240	4
			Max	5435	1062	67	265	
280	VV00009	VMD 8000/6	Min	4130	1470	98	298	5,5
			Max	8065	1100	107	340	
	VV00010	VMD 10000/6	Min	4294	1443	98	300	5,5
			Max	9693	1000	107	357	
295	VV00011	VMD 14000/6	Min	7642	1316	145	430	7,5
			Max	13955	1000	153	490	
	VV00012	VMD 16000/6	Min	7963	1293	146	433	11
			Max	15950	956	160	509	
297	VV00001	VMD 18000/6	Min	8225	1435	186	563	11
			Max	17980	1000	197	649	
	VV00002	VMD 23000/6	Min	10410	1410	227	631	15
			Max	22885	1000	252	741	
	VV00003	VMD 27000/8	Min	12065	1115	164	631	15
			Max	26635	750	164	741	
310	VV00004	VMD 33000/6	Min	17650	1220	288	895	18,5
			Max	32583	935	312	1005	
	VV00005	VMD 38000/6	Min	20448	1153	298	949	18,5
			Max	37881	882	323	1078	
	VV00006	VMD 42000/8	Min	20060	1087	260	949	18,5
			Max	42060	750	260	1116	
320	VV00007	VMD 60000/8	Min	39570	1000	434	1451	30
			Max	60560	815	442	1580	
	VV00013	VMD 74000/8	Min	43580	940	423	1520	30
			Max	73440	750	453	1703	
360	VV00014	VMD 103000/8	Min	58862	945	576	2232	45
			Max	102955	741	620	2450	
	VV00015	VMD 120000/8	Min	65940	900	585	2335	55
			Max	119525	694	632	2600	

Mechanical exciters

General technical features

- Static Moment from 3140 to 119525 Kgmm.
- Static moment can be adjusted by means of additional steel or lead weights.
- Centrifugal Force from 63KN to 632KN.
- Ambient temperature from -40°C to +70°C
- Mounting of VMD exciter in every position always with horizontal shaft.
- Casing in spheroidal cast iron.
- Gears and bearings lubrication by immersion and spray of oil.
- Spherical roller bearings. Bearing life over 40000 working hours in heavy duty conditions.

VMD exciters is supplied with coupling flange (DIN standard) for driving shaft, weight, covers, extra weights for the required weight setting. Complete driving system is available on request together with different fixing holes patterns.

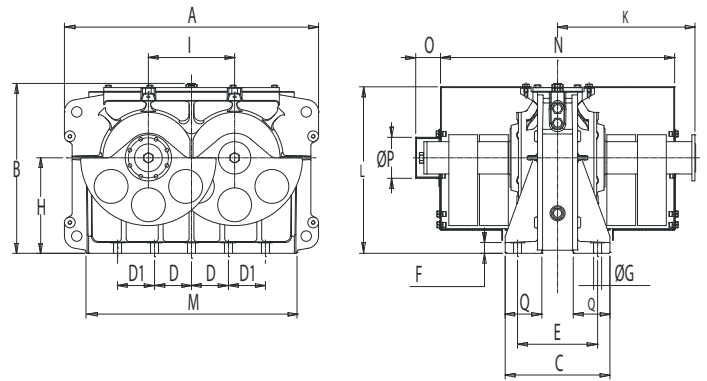

Dimensioni mm. – Dimensional Specification mm.

Dimensioni mm. – Dimensional Specification mm.																		
A	B	C	Interassi di fissaggio Fixing dimensions					N°	F	H	I	K	L	M	N	O	ØP	Q
			D	D1	E	ØG												
655	410	250	1x190	2x110	165	22	8xM20	25	225	210	320,5	407,5	545	530	69,5	97	88	
700	453,5	260	1x190	2x110	165	22	8xM20	30	240	232	330,5	442,5	575	555	69,5	97	95	
700	453,5	260	1x190	2x110	165	22	8xM20	30	240	232	331,5	442,5	575	555	69,5	97	95	
760	508,5	270	1x220	2x110	190	26	8xM24	30	280	256	389	497,5	640	670	69,5	107	87	
760	508,5	270	1x220	2x110	190	26	8xM24	30	280	256	389	497,5	640	670	69,5	107	87	
825	551,5	340	4x120	-	260	26	10xM24	35	310	280	407	540,5	685	685	80,5	133	119	
825	551,5	340	4x120	-	260	26	10xM24	35	310	280	446	540,5	685	760	80,5	133	119	
825	551,5	340	4x120	-	260	26	10xM24	35	310	280	476	540,5	685	820	80,5	133	119	
925	629	380	5x120	-	300	32	12xM30	35	350	320	476,5	618	770	815	83	143	128,5	
925	629	380	5x120	-	300	32	12xM30	35	350	320	510,5	618	770	885	83	143	128,5	
925	629	380	5x120	-	300	32	12xM30	35	350	320	524,5	618	770	915	83	143	128,5	
1070	708	470	4x120	2x150	390	32	14xM30	35	390	370	499	698,5	920	970	30	208	150	
1070	708	470	4x120	2x150	390	32	14xM30	35	390	370	592	698,5	920	1045	85	161	150	
1280	830	500	1x280	4x160	410	39	12xM36	45	460	440	629,5	821	1135	1075	115,5	200	152	
1280	830	500	1x280	4x160	410	39	12xM36	45	460	440	661,5	821	1135	1140	115,5	200	152	



VENANZETTI VIBRAZIONI MILANO Srl

Via Ghiarola Nuova 22 - 41042 Fiorano Modenese (Modena) Italy

Tel. +39 0536 832300 | Fax +39 0536 910462

www.venanzettivibrazioni.com | info@venanzettivibrazioni.com